

PHILIPS

DreamStation Go

Auto CPAP
CPAP

User manual



Table of contents

1. Safety Information.....	1
Intended use	1
Warnings	1
Cautions	4
Contraindications	6
Safety Symbols Glossary.....	6
2. System Overview.....	10
System Contents.....	10
Accessories.....	10
System Diagram.....	11
3. Therapy Device	12
Where to Place Your Device	12
Supplying AC Power to Your Device.....	12
Starting the Device.....	13
Navigating the Device Screens.....	14
Therapy On Menu Navigation Settings.....	15
Ramp Feature	15
Therapy Off Menu Navigation Settings.....	16
My Info.....	16
My Comfort.....	17
My Device	18
My Support.....	19
Check Mask Fit.....	20
Pairing Therapy Device to <i>Bluetooth</i> [®] -enabled Mobile Device.....	21
Device Pop-Up Messages.....	22
4. Tubing.....	25
Tubing Types.....	25
Connecting the Tubing to Your Device	25
Changing Your Tube Type.....	26
Cleaning the Tubing.....	27
Tubing Device Pop-Up Messages.....	27
5. Filter.....	28
Filter Types.....	28
Installing or Replacing the Filter	29
Filter Device Pop-Up Messages.....	29
6. Accessories.....	30
Using the USB Port and the Micro USB Port	30
Using the microSD Card.....	31

microSD card Device Pop-Up Messages	32
7. Battery Pack	33
Indicators and Buttons on the Battery Pack.....	33
Preparing the Battery Pack for First Use and Recharging.....	35
Attaching the Battery Pack to the Device	35
Disconnecting the Battery Pack.....	37
8. Care and Maintenance.....	38
Caring for the Therapy Device or Battery Pack.....	38
Caring for the Reusable Filter	38
9. Troubleshooting	40
Tips and Tricks.....	40
Contacting Customer Service.....	42
10. Additional Notes.....	43
Traveling with the System	43
Airline Travel	43
Altitude Compensation	43
Adding Supplemental Oxygen.....	43
Service	43
Additional Notices.....	44
Specifications.....	45
Disposal.....	48
EMC Information.....	48
Limited warranty	52

1. Safety Information

Intended use

The Philips Respironics DreamStation Go systems deliver positive airway pressure therapy for the treatment of Obstructive Sleep Apnea in spontaneously breathing patients weighing over 30 kg (66 lbs.). It is for use in the home or hospital/institutional environment.

Important

This device is to be used only on the instruction of a licensed physician. Your supplier will make the correct pressure settings according to your health care professional's prescription.

Several accessories are available to make your Obstructive Sleep Apnea (OSA) treatment with the DreamStation Go system as convenient and comfortable as possible. To ensure that you receive the safe, effective therapy prescribed for you, use only Philips Respironics accessories.

Warnings

A warning indicates the possibility of injury to the user or operator.

Device usage	This device is not intended for life support.
Personnel qualifications	This manual serves as a reference. The instructions in this manual are not intended to supersede your health care professional's instructions regarding the use of the device.
	The operator should read and understand this entire manual before using the device.
Operating and storage temperatures	Do not use this device if the room temperature is warmer than 95° F (35° C) because the temperature of the airflow may exceed 109° F (43° C). This could cause thermal irritation or injury to the patient's airway.
	Do not use the device while positioned in a warm place, such as direct sunlight or near a heating appliance. These conditions can increase the temperature of the airflow and could cause thermal irritation or injury to the patient's airway.
Bacteria filter	If the device is used by multiple persons in a hospital environment (such as rental devices), a low-resistance, main flow bacteria filter should be installed in-line between the device and the circuit tubing to prevent contamination.
	If the device is used on multiple users, discard and replace the bacteria filter each time the device is used on a different person.

1. Safety Information

Patient circuits and tubing	<p>The device should be used only with masks and connectors recommended by Philips Respironics or with those recommended by the health care professional or respiratory therapist. A mask should not be used unless the device is turned on and operating properly. The exhalation port(s) associated with the mask should never be blocked.</p> <p>Explanation of the Warning: The device is intended to be used with special masks or connectors that have exhalation ports to allow continuous flow of air out of the mask. When the device is turned on and functioning properly, new air from the device flushes the exhaled air out through the mask exhalation port. However, when the device is not operating, enough fresh air will not be provided through the mask, and exhaled air may be rebreathed.</p>
	<p>If you are using a full face mask (a mask covering both your mouth and your nose), the mask must be equipped with a safety (entrainment) valve.</p>
	<p>Do not pull or stretch the tubing. This could result in circuit leaks.</p>
	<p>Inspect the tubing for damage or wear. Discard and replace the tubing as necessary.</p>
Improperly functioning device	<p>If you notice any unexplained changes in the performance of the device, if it is making unusual sounds, if water is spilled into the enclosure, or if the enclosure is cracked or broken, discontinue use and contact your supplier.</p>
Power cord	<p>Route the power cord to the outlet in a way that will prevent the cord from being tripped over or interfered with by chairs or other furniture.</p> <p>This device is activated when the power cord is connected.</p> <p>Use only power cords supplied by Philips Respironics for this device. Use of power cords not supplied by Philips Respironics may cause overheating or damage to the device.</p> <p>To avoid strangulation hazards, ensure that all cords connected to the device and battery pack are properly routed.</p>

Accessories	<p>Do not use any accessories, detachable parts, and materials not recommended by Philips Respironics. Incompatible parts or accessories can result in degraded performance.</p> <p>The USB charging port is designed only for use in charging a mobile device, such as a cell phone. Ensure there are no additional accessories attached to the mobile device while connected to this charging port.</p> <p>Use of accessories, transducers and cables other than those specified or provided by the manufacturer of this equipment could result in increased electromagnetic emissions or decreased electromagnetic immunity of this equipment and result in improper operation.</p>
Oxygen	<p>When using oxygen with this system, the oxygen supply must comply with local regulations for medical oxygen.</p> <p>Do not connect the device to an unregulated or high pressure oxygen source.</p> <p>When using oxygen with this system, a Philips Respironics pressure valve must be placed in-line with the patient circuit between the device and the oxygen source. The pressure valve helps to prevent the back flow of oxygen from the patient circuit into the device when the unit is off. Failure to use the pressure valve could result in a fire hazard.</p> <p>Oxygen supports combustion. Oxygen should not be used while smoking or in the presence of an open flame.</p> <p>Do not use the device in the presence of a flammable anesthetic mixture in combination with oxygen or air, in the presence of nitrous oxide, or in an oxygen-enriched environment.</p> <p>Do not use the device near a source of toxic or harmful vapors.</p> <p>When using oxygen with this system, turn the device on before turning on the oxygen. Turn the oxygen off before turning the device off. This will prevent oxygen accumulation in the device. Explanation of the Warning: When the device is not in operation and the oxygen flow is left on, oxygen delivered into the tubing may accumulate within the device's enclosure. Oxygen accumulated in the device enclosure will create a risk of fire.</p>
EMC	<p>Use of this equipment adjacent to or stacked with other equipment should be avoided because it could result in improper operation.</p> <p>The Health Industry Manufacturers Association recommends that a minimum separation of six inches be maintained between a wireless phone and a pacemaker to avoid potential interference with the pacemaker. The DreamStation Go on-board <i>Bluetooth</i> communication should be considered a wireless phone in this regard.</p>

1. Safety Information

Care and Maintenance	Periodically inspect electrical cords, cables, tubing, and accessories for damage or signs of wear. Discontinue use and replace if damaged.
	Repairs and adjustments must be performed by Philips Respironics-authorized service personnel only. Unauthorized service could cause injury, invalidate the warranty, or result in costly device damage. Contact your supplier for maintenance.
	Do not attempt to modify the device or battery pack in any way.
	Periodically check battery pack charge status and recharge if depleted.
	To avoid electrical shock, always unplug the power cord from the wall outlet before caring for the device. DO NOT immerse the device in any fluids.
	Do not submerge the battery pack in water or any other liquid.
Choking	This device contains small parts which could result in a choking hazard.
Nebulization	Nebulization or humidification can increase the resistance of breathing system filters and the operator must monitor the breathing system filter frequently for increased resistance and blockage to ensure the delivery of the therapeutic pressure.
General	Contact your health care professional if symptoms of sleep apnea recur.



Cautions

A caution indicates the possibility of damage to the device.

US Federal Caution	U.S. federal law restricts this device to sale by or on the order of a physician.
EMC	Medical electrical equipment needs special precautions regarding EMC and needs to be installed according to EMC information. Contact your supplier regarding EMC installation information.
Mobile RF Communications	Portable RF communications equipment (including peripherals such as antenna cables and external antennas) should be used no closer than 30 cm (12 in.) to any part of the [ME EQUIPMENT or ME SYSTEM], including cables specified by the manufacturer. Otherwise, degradation of the performance of this equipment could result.
Device usage	Before operating the device, ensure that both end caps are attached whenever any of the accessories such as the battery pack is not installed.
	Ensure that the therapy device is properly secured if it is being used in a portable environment.

Electrostatic Discharge (ESD)	Pins of connectors shall not be touched and connections shall not be made without special precautions. Precautionary procedures include methods to prevent build-up of electrostatic charge (e.g., air conditioning, humidification, conductive floor coverings, non-synthetic clothing), discharging one's body to the frame of the equipment or system or to earth. It is recommended that all individuals that will handle this device understand these precautionary procedures at a minimum as part of their training.
Condensation	Condensation may damage the device. If the device has been exposed to either very hot or very cold temperatures, allow it to adjust to room temperature (operating temperature) before starting therapy. Do not operate the device outside of the operating temperature range shown in the Specifications section later in this manual.
Filters	<p>A properly installed, undamaged Philips Respironics reusable filter or disposable, fine filter is required for proper operation.</p> <p>Clogged inlet filters may cause high operating temperatures that may affect device performance. Regularly examine the inlet filters as needed for integrity and to check for accumulated debris.</p> <p>Never install a wet filter into the device. You must ensure sufficient drying time for the rinsed filter.</p> <p>Make sure the air inlet holes on the side of the device are not blocked by bedding, curtains, or other items. Air must flow freely around the device for the system to work properly.</p>
Battery Pack	<p>Do not expose the battery pack to extreme temperatures (see the Specifications section for temperature specifications). If the battery pack becomes very hot or very cold, allow it to come to room temperature before using.</p> <p>There are no user-serviceable parts inside of the battery pack; therefore, do not attempt to disassemble or repair it.</p>
Extension cords	Do not use extension cords with this device.
Device placement	<p>Do not place the device in or on any container that can collect or hold water.</p> <p>Do not place the device directly onto carpet, fabric, or other flammable materials.</p>
Tobacco use	Tobacco smoke may cause tar build-up within the device, which may result in the device malfunctioning.

Contraindications





When assessing the relative risks and benefits of using this equipment, the clinician should understand that this device can deliver pressures up to 20 cm H₂O. In the event of certain fault conditions, a maximum pressure of 40 cm H₂O is possible. Studies have shown that the following pre-existing conditions may contraindicate the use of CPAP therapy for some patients:











- Bullous Lung Disease
- Pathologically Low Blood Pressure
- Bypassed Upper Airway
- Pneumothorax
- Pneumocephalus has been reported in a patient using nasal Continuous Positive Airway Pressure. Caution should be used when prescribing CPAP for susceptible patients such as those with: cerebral spinal fluid (CSF) leaks, abnormalities of the cribriform plate, prior history of head trauma, and/or pneumocephalus. (Chest 1989; 96:1425-1426)

The use of positive airway pressure therapy may be temporarily contraindicated if you exhibit signs of a sinus or middle ear infection. Not for use with patients whose upper airways are bypassed. Contact your health care professional if you have any questions concerning your therapy.











Safety Symbols Glossary

The following symbols may appear on the device and accessories:

Symbol	Title and Meaning	Reference
	Operator's manual; operating instructions Consult instructions for use.	IEC 60878 ISO 7000-1641 Symbol 5.4.3, ISO 15223-1
	Approved for airline use.	RTCA/DO-160G section 21, category M
	AC power (Alternating current) Indicates on the rating plate that the equipment is suitable for alternating current only; to identify relevant terminals.	IEC 60417-5032
	Separate collection for electrical and electronic equipment.	EC Directive 2012/19/ EU

Symbol	Title and Meaning	Reference
	Li Ion Battery	-
	<i>Bluetooth</i> [®] symbol Indicates the device has <i>Bluetooth</i> capabilities.	-
IP22	Drip proof equipment Protection against ingress of solid foreign objects \geq 12.5 mm diameter. Protection against ingress of water with harmful effects dripping (15° tilted).	-
	Non-ionizing electromagnetic radiation Indicates that the equipment includes RF transmitters.	IEC 60878 IEC 60417-5140
	Caution, consult accompanying documents.	IEC 60878 Symbol 5.1.2, ISO 15223-1
	Prescription device Caution: U. S. federal law restricts this device to sale by or on the order of a physician.	-
	Electrostatic sensitive devices (ESD warning symbol) Attention – Observe precautions for handling electrostatic sensitive devices.	IEC 60878 IEC 60417-5134
	Serial connection Identifies a connector for a serial data connection.	IEC 60878 IEC 60417-5850
	Class II equipment (Double Insulated) To identify equipment meeting the safety requirements specified for Class II equipment.	IEC 60878 IEC 60417-5172
	Keep away from sunlight Indicates the medical device needs protection from light sources.	IEC 60878 ISO 7000-0624 Symbol 5.3.2, ISO 15223-1
	Type BF applied part To identify a type BF applied part complying with IEC 60601-1.	IEC 60878 IEC 60417-5333

1. Safety Information

Symbol	Title and Meaning	Reference
	Do not disassemble.	-
	For indoor use only Equipment is designed primarily for indoor use.	IEC 60878 IEC 60417-5957
	Manufacturer Indicates the medical device manufacturer.	IEC 60878 ISO 7000-3082 Symbol 5.1.1, ISO 15223-1
	Date of manufacture Indicates the date when the medical device was manufactured.	IEC 60878 ISO 7000-2497 Symbol 5.1.3, ISO 15223-1
	Reorder number Indicated the manufacturer's catalogue number so the medical device can be identified.	ISO 7000-2493 Symbol 5.1.6, ISO 15223-1
	Serial number Identify the manufacturer's serial number for the medical device.	IEC 60878 ISO 7000-2498 Symbol 5.1.7, ISO 15223-1
	Keep dry Indicates the medical device that needs to be protected from moisture.	IEC 60878 ISO 7000-0626 Symbol 5.3.4, ISO 15223-1
	Fragile, handle with care Indicates the medical device can be broken or damaged if not handled carefully.	IEC 60878 ISO 7000-0621 Symbol 5.3.1, ISO 15223-1
	Humidity limitation Indicates the range of humidity to which the medical device can be safely exposed.	IEC 60878 ISO 7000-2620 Symbol 5.3.8, ISO 15223-1
	Temperature limit Indicates the storage temperature limits to which the medical device can be safely exposed.	IEC 60878 ISO 7000-0632 Symbol 5.3.7, ISO 15223-1

ISO 7000:2014, Graphical symbols for use on equipment – Registered symbols

ISO 7010:2011+A1:2012+A2:2012+A3:2012+A4:2013+A5:2014+A6:2014, Graphical symbols -- Safety colours and safety signs -- Registered safety signs (not currently FDA recognized)

EN 15986:2011, Symbols for medical devices containing phthalates (not currently FDA recognized)

ISO 15223-1:2012, Medical devices—Symbols to be used with medical devices labels – General requirements

IEC 60417:2002 DB, Graphical symbols for use on equipment

IEC/TR 60878:2015, Graphical symbols for electrical equipment in medical practice

2. System Overview

The DreamStation Go CPAP is a Continuous Positive Airway Pressure therapy device designed for the treatment of Obstructive Sleep Apnea (OSA). Your supplier will choose the appropriate pressure settings for you.

Several accessories are also available for use with your device. Contact your supplier to purchase any accessories not included with your system.

System Contents

Your DreamStation Go system may include the following items:

• Device	• microSD Card (optional)
• User Manual	• Disposable Fine Filter (optional)
• Reusable Filter	• Battery Pack (optional)
• 12 mm Micro-flexible Tubing (12 Type)	
• 6 ft. (1.83 m) Power Cord	

Note

If any of these items are missing, contact your supplier.

Accessories

The following accessories are available for your DreamStation Go system:

• 6 ft. (1.83 m) Serial Communication Cable (with ferrites)	• 10 ft. (3.04 m) Power Cord
• Small Travel Kit	• Medium Travel Kit
• 15 mm Standard Tubing (15 Type)	• 22 mm Performance Tubing (22 Type)
• Bacteria Filter	• Pressure Valve (for use with supplemental oxygen)

Note

Your mobile device charging cable should not be longer than 6 ft (1.83 m).

System Diagram

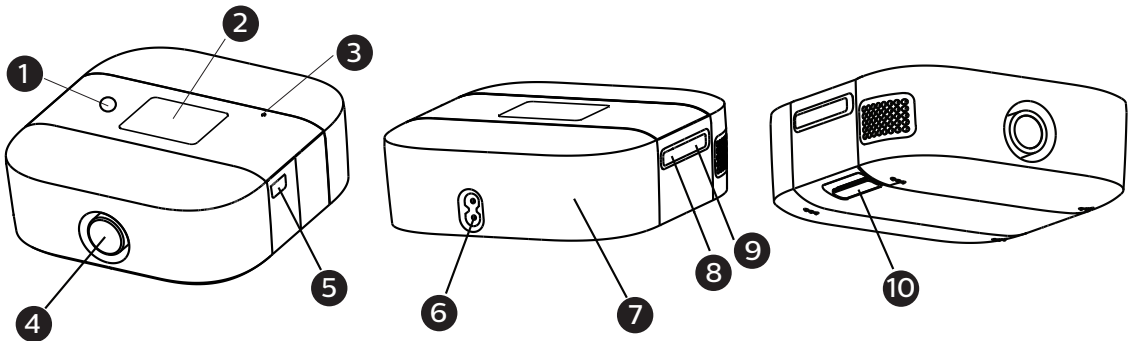

The figure above illustrates some of the device features, described in the following table.

#	Feature	Description
1	Therapy on/off button ○	Starts and stops the airflow for therapy.
2	Display Touchscreen	This is the User Interface for the therapy device.
3	Ambient Light Sensor	Detects room light levels and adjusts brightness of the display screen.
4	Air Outlet Port	Connect the tubing here.
5	Serial Connector	Access the serial connector here.
6	AC Power Inlet	Connect the power cord here.
7	Battery Pack Access	This end cap slides off for access to the battery pack connection.
8	microSD Card	Access the microSD card here.
9	Mobile Charging Port	Access the USB charging port here for mobile device usage.
10	Filter Access	Access the filter here.

3. Therapy Device

Where to Place Your Device

Place the device on a firm, flat surface somewhere within easy reach of where you will use it. The device should sit at a level lower than your sleeping position. Make sure the device is away from any heating or cooling equipment (e.g., forced air vents, radiators, air conditioners).

Note

When positioning the device, make sure that the power cable is accessible because removing power is the only way to turn off the device.

Supplying AC Power to Your Device

Complete the following steps to operate the device by plugging the AC power cord into an electrical outlet.

1. Plug the power cord connector into the power inlet on the back of the device.

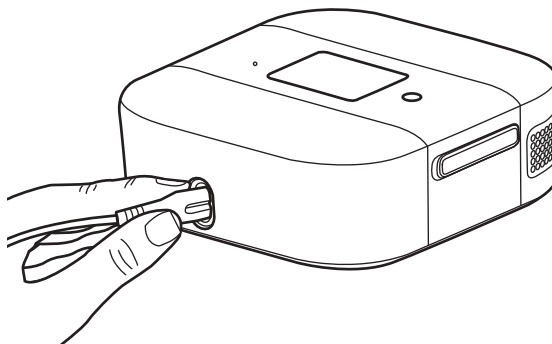

2. Plug the pronged end of the AC power cord into an electrical outlet that is not controlled by a wall switch.

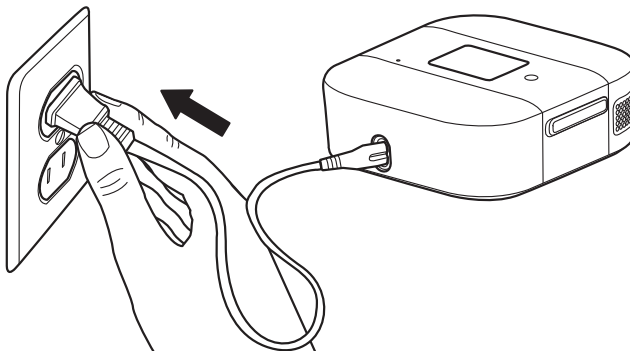

3. Make sure that all connections are secure.

Starting the Device

1. Ensure power is supplied to the device. **Tap anywhere on the display screen to wake up the device.**



#	Feature
1	Therapy on/off button
2	Display Touchscreen

2. Put on your mask assembly. Refer to the instructions supplied with the mask.
3. Tap the therapy button  on top of the device to turn on airflow and begin therapy. The current delivered pressure will display on the screen. The therapy button is **only for therapy**.
4. A small amount of mask leak is normal and acceptable. Correct large amount of mask leaks or eye irritation by adjusting your mask headgear. See the instructions provided with your mask for more information, or refer to the Check Mask Fit section.
5. Tap the therapy button again to turn off the therapy. To turn off therapy when the display screen is off, place and hold a finger on the display screen for three seconds. Alternatively, tap anywhere on the display screen to wake up the display and then tap the therapy button to turn off therapy.

Notes

- If you are using the device in a bed with a headboard, try placing the tubing over the headboard. This may reduce tension on the mask.
- During therapy, if there is a power loss, the device will return to the home screen once power is restored. You may resume therapy as needed.





Navigating the Device Screens

The User Interface (UI) on this device allows you to adjust the device settings and view information about your therapy. The UI consists of the display screen and the touch panel. Swipe left or right on the touch panel to scroll through the menu options on the display screen.

To adjust a setting:

1. Swipe the touchscreen until you find your desired menu option.
2. Tap the desired menu option.
3. Swipe the touchscreen until you find the sub-menu option and tap to select that setting.
4. Swipe the touchscreen to change the setting.
5. Tap the icon or tap the up arrow  in the upper left corner of the display to save the setting, and return to the previous menu option.

Notes

- The swipe icon  on any screen indicates to swipe the display left or right to perform an action.
- The tap icon  on any screen indicates to press the display to perform an action.
- Tapping the down arrow on the display when the down arrow  appears on any screen will take you to a sub-menu with more menu options. Tapping the up arrow when the up arrow  appears on any sub-menu will return you back to the main menu.
- The screens shown throughout this manual are examples for reference only. Actual screens may vary based upon device model and supplier settings.

Therapy On Menu Navigation Settings

While the device is delivering therapy, you can adjust or view the following settings.

#	Feature	Description
1	Therapy pressure	Displays the current delivered pressure.
2	Ramp Feature	The device is equipped with an optional ramp feature that your supplier can enable or disable.



Ramp Feature

This feature reduces the air pressure when you are trying to fall asleep and then gradually increases (ramps) the pressure until your prescription setting is reached, allowing you to fall asleep more comfortably.

If ramp is enabled on your device, after you turn on the airflow, tap the Ramp () icon on the display. You can use the ramp feature as often as you wish.

When you tap the Ramp icon, the therapy screen will change to reflect the ramp in pressure, and the numbers within the blue circle will reflect the gradual increase in pressure.



Your device has two ramp modes. Your supplier will select the one that is most appropriate for you. The standard ramp mode increases pressure at a steady rate. Alternately, the SmartRamp mode maintains a constant lower pressure until the device detects that you require more pressure.

3. Therapy Device

Therapy Off Menu Navigation Settings

From the Home screen, you can scroll between the following four options:

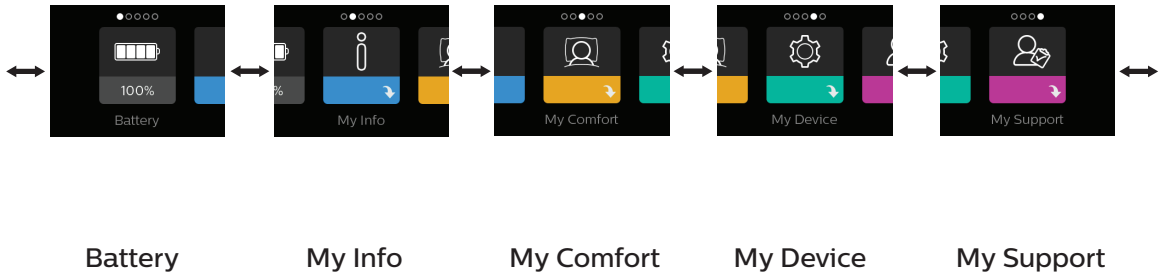

Battery	This menu is visible when the battery pack is connected. See Chapter 7, Battery Pack for details.
My Info	This menu provides summary statistics of your therapy use.
My Comfort	This menu contains comfort settings that you can adjust as needed.
My Device	This menu contains device settings that you can change.
My Support	This menu contains information that your supplier may direct you to read to them so they can better assist you over the phone.

My Info

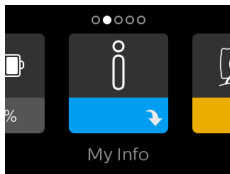



When you select **My Info**, you will be able to view the following screens. You cannot change settings in the My Info menu. These screens are only for reference. Your supplier may periodically ask you for this information. If any of the below options are not visible, your supplier did not enable those options.



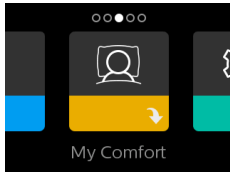

Icon	Text	Description
	Therapy Hours	This screen displays the amount of time the user is actually receiving therapy on the device for the most recent 1-day time frame.
AHI	AHI	This screen displays the nightly Apnea/Hypopnea indices (AHI) value for the most recent 1 day time frame.

Icon	Text	Description
	Mask Fit	Displays the value “100% minus Large Leak”. Large Leak is the percentage of time that the mask leak was so high that it is no longer possible for the device to identify respiratory events with statistical accuracy. Displays the value for the most recent 1 day.



My Comfort



When you select **My Comfort**, you will be able to view the following screens. You can change the settings in the setup menu. These screens will only display if they are available and enabled on your device. If any of the below options are not visible, your supplier did not enable those options. If a lock icon  is displayed on this screen, it indicates that your supplier has locked this setting and you cannot change it.

Icon	Text	Description
	Ramp	This displays the ramp starting pressure. You can increase or decrease the ramp starting pressure in 0.5 cm H ₂ O increments.
	Ramp time	When you set the ramp time, the device increases the pressure from the value set on the ramp screen to the therapy pressure setting over the length of time specified here.
	Flex	This allows you to adjust the level of air pressure relief that you feel when you exhale during therapy. Your supplier can enable or disable this feature. When your supplier enables Flex, a level will already be set for you on the device. You can increase or decrease the setting from 1 to 3. The setting of “1” provides a small amount of pressure relief, with higher numbers providing additional relief.
	Mask type	This setting allows you to adjust the level of air pressure relief based on the specific Philips Respironics mask. Each Philips Respironics mask may have a “System One” resistance control setting. Contact your supplier if you cannot find this resistance setting for your mask.



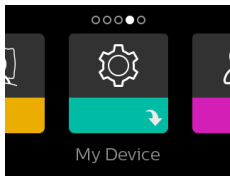

3. Therapy Device

Icon	Text	Description
	Tube type	This setting allows you to select the correct tubing type that you are using with the device. You can choose (12) for the Philips Respironics 12 tubing type, (15) for the Philips Respironics 15 tubing type, or (22) for the Philips Respironics 22 tubing type. Note: The 12 type and 15 type tubing are identified on the cuff with the tubing identifier symbol: “12” or “15”. The 22 tubing type does not have any identifier on the cuff.
	Check mask fit	This feature allows you to check the fit of your mask prior to starting therapy. This is done by measuring the amount of leak.

My Device





When you select **My Device**, you will be able to view the following screens. You can change the settings in the setup menu. These screens will only display if they are available and enabled on your device. If any of the below options are not visible, your supplier did not enable those options.

Icon	Type	Description
	Therapy Ring	This setting controls the therapy button LED light ring during therapy. The LED light ring will remain on during therapy if you select Light On. The LED light ring will fade with the display backlight if you select Light Dims.
	Language	This feature allows you to choose which language to display on the interface.
	Bluetooth	This feature allows you to turn <i>Bluetooth</i> off and on. Also, it allows you to clear the pairing with a compatible <i>Bluetooth</i> device.
	Time	This setting allows you to adjust the time. The default setting is Greenwich Mean Time, but you may adjust the time in 30 minute increments to match your local time zone. Note: This time setting should not be used as a clock function on the device. It is to align your therapy data for your supplier’s data reports.

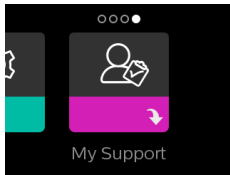
My Support



When you select **My Support**, you will be able to view the following screens. You cannot change settings in the support menu. These screens are only for reference. Your supplier may periodically ask you for this information. If any of the below options are not visible, your supplier did not enable those options.

Icon	Text	Description
	Device Info	This screen displays your therapy device information: serial number, model, and software version.
	Performance Check	Your device is equipped with a self-diagnostic tool called “Performance Check.” This tool can evaluate your device for certain errors. It also allows you to share key device settings with your supplier. Use Performance Check when directed to by your supplier. At conclusion of the scan, the screen displays a green checkmark if no issue is detected. If device displays a red “X,” please contact your supplier for assistance.
	Phone-In	This screen displays the total therapy hours and total blower hours for the device, and a compliance check number used by your supplier to validate that data provided by you is the data taken from this screen.

Check Mask Fit

The optional **Check Mask Fit** feature can be enabled or disabled by your supplier. This feature allows you to check the fit of your mask prior to starting therapy.

1. Put on your mask assembly. Refer to your mask instructions if needed.
2. Navigate to the **Check Mask Fit** screen under **My Comfort** and tap the display to initiate the check.
3. The device will deliver a test pressure while the screen counts down 40 seconds.

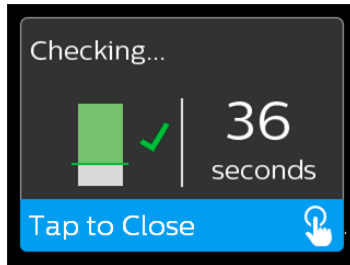

4. After the test is complete, the screen will either display a green checkmark or a red "X". The green checkmark indicates that there is an appropriate amount of leak. The red "X" indicates that the leak may affect device performance, however, the device will remain functional and deliver therapy.

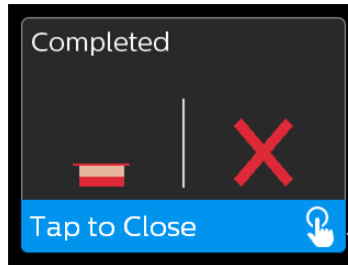
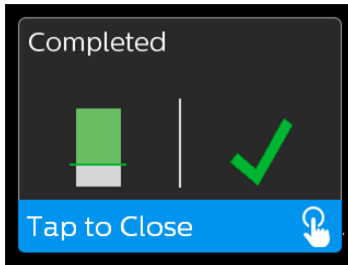

Note

If you choose to try to improve your mask fit, you can stop therapy, adjust the fit of your mask, and rerun the **Check Mask Fit** feature. Refer to the instructions that came with your mask and headgear for the proper fitting procedure.

Pairing Therapy Device to *Bluetooth*[®]-enabled Mobile Device

Your device may have *Bluetooth* wireless technology, which is one method by which you can transfer your therapy device's data to **DreamMapper**. DreamMapper is a mobile and web-based system designed to help you enhance your sleep therapy experience.

Notes

- You can only pair your therapy device to one mobile device at any given time.
- Pairing works best when your therapy device and mobile device are in the same room.
- The current version of DreamMapper will guide you through these instructions.
- After initiating pairing, you will have 30 seconds to complete the setup. After this time, it will be cancelled automatically.

Follow the steps below to manually pair to your mobile phone or tablet.

1. Install DreamMapper on your mobile device.
2. With your therapy device powered up and the blower off, initiate *Bluetooth* Setup from the DreamMapper mobile app.
3. The therapy device will appear as **PR BT XXXX** (XXXX will be the last four digits of the serial number listed on the bottom of your therapy device or in **My Support** settings).
4. Your mobile device will require you to confirm pairing via one of these two methods:

— *Enter a PIN code*

The following icon will appear on your therapy device screen with Pair?: 

Swipe left or right to select “yes,” and tap the display to confirm your setting. Your therapy device will display a 6 digit PIN. Enter this PIN on your mobile device to complete pairing.

— *Confirm a PIN code*

The following icon will appear on your therapy device screen with a 6-digit PIN and Pair?:











Verify that the PIN is the same on both the therapy device and the mobile device. If so, swipe the therapy device's display to select “yes” and tap the display to select. Then, accept on the mobile device to complete pairing.

Device Pop-Up Messages



Device pop-ups are messages that show up on the user interface screen. Additional pop-up messages are contained in each chapter.

The following summary table summarizes the messages:

Condition	Icon	Description	Possible Cause	Action
Time		Prompts to set the time.	n/a	Set the time on the device.
Sleep Progress	n/a	Shows a three night summary of therapy.	n/a	Tap the display to acknowledge and clear the message.
Change Accepted		Confirms acceptance of prescription change or device upgrade.	n/a	Tap the display to acknowledge and clear the message.
Pair?: 123456 Yes/No		Prompts to accept or decline pairing to a <i>Bluetooth</i> compatible device. This device can be identified by the digits displayed.	n/a	Swipe the display to accept pairing (Yes), or decline (No), then tap the display to confirm selection. The pop-up will timeout after 30 seconds and the pairing will be cancelled if you do not select Yes.

Condition	Icon	Description	Possible Cause	Action
Bluetooth LE Passkey		Prompts to accept or decline pairing to a <i>Bluetooth</i> compatible device before displaying the pairing passkey.	n/a	If you selected Yes to accept pairing, the <i>Bluetooth</i> LE Passkey will display a passkey on the screen. Enter the passkey on your mobile device to pair. The pop-up will timeout after 30 seconds and the pairing will be cancelled if you do not use the passkey.
Patient Message		Message from your supplier.	n/a	Tap the display to acknowledge and clear the message.
Change Rejected		A prescription or settings change was rejected.	Change missing or incorrect.	Contact your supplier.
Service Required		Indicates an error which enters device into "Safe State." This allows power to remain on but airflow is disabled.	Device error	Disconnect device from power. Reattach power cord to restore power. If the alert continues to occur, contact your supplier.
Automatic Off		Displayed when therapy ends due to automatic off function.	The mask has been removed.	Put your mask back on, confirm good fit, and turn airflow on to resume therapy.
Loading Language and Rebooting		Displayed when a new language is selected from the menu.	n/a	No action needed. Times out when complete.

3. Therapy Device

Condition	Icon	Description	Possible Cause	Action
Busy		Displayed when the device is temporarily inaccessible due to data communication.	n/a	No action needed.
Software Upgrade		Prompts to update the device for software changes.	n/a	Choose between “Yes”/”No” when asked to upgrade the software. If “yes” is selected, the upgrade will be made. Do not remove from power. If you select “no”, the message will be cleared.

4. Tubing

Tubing Types

There are three different types of tubing that you may use with your DreamStation Go therapy device. You must select the tube type on your device.

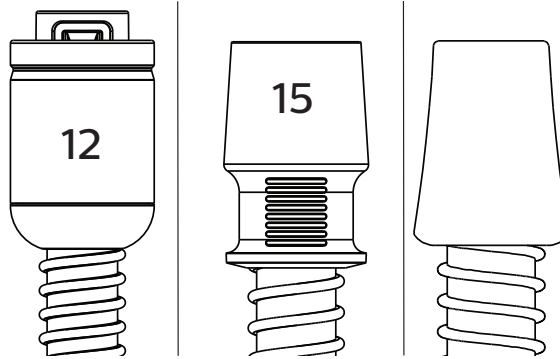

12 tubing type | **15 tubing type** | **22 tubing type**

The 12 tubing type will have a “12” identified on the tubing cuff (as shown in the image above). The 15 tubing type will have a “15” identified on the tubing cuff (as shown in the image above). The 22 tubing type does not have any number or symbol on the tubing cuff (as shown in the image above).

Connecting the Tubing to Your Device

To connect the tubing to your device, you will need the following Philips Respironics accessories:

- Nasal or full face mask (interface) with built-in exhalation, or a nasal or full face mask (interface) with a separate exhalation device attached (such as the *Whisper Swivel II*)
- Flexible tubing, 6 ft. (1.83 m)
- Mask headgear

4. Tubing

Follow these steps to connect tubing to your device:

1. Insert the 12, 15 or 22 tubing type cuff into the air outlet port on your therapy device.

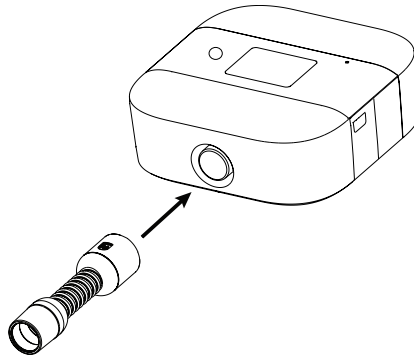

2. Connect the tubing to your mask. For proper placement and positioning, refer to the instructions that came with your mask.

Note

You may use a standard tube with a bacteria filter. If required, connect a bacteria filter to the device air outlet, and then connect the flexible tubing to the outlet of the bacteria filter. When using the bacteria filter, the device performance may be affected. However, the device will remain functional and deliver therapy.

Changing Your Tube Type

Change your tube type by navigating to **My Comfort** -> **Tube Type**. Swipe left or right to switch between tube types.

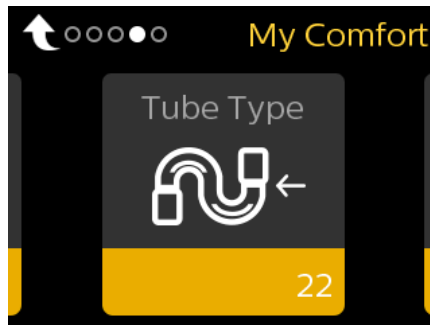

For more information on navigation or selection, please refer to **Chapter 3, Navigating the Device Screens** or **My Comfort**.

Cleaning the Tubing

Clean the tubing before first use and daily.

1. Disconnect the flexible tubing from the device.
2. Gently wash the tubing in a solution of warm water and a mild detergent.
3. Rinse thoroughly.
4. Air dry. Inspect the tubing for damage or wear. Discard and replace as necessary.

Tubing Device Pop-Up Messages

Device pop-ups are messages that show up on the user interface screen.

Condition	Icon	Description	Possible Cause	Action
Low leak: Check mask and tube		Blocked airway	Blockage at tube or mask	Check tube is not crushed or folded, such that airflow is restricted. Check mask is attached properly and without any obstruction.

5. Filter

Filter Types

You may use either a reusable filter that is washable, or a disposable, fine filter.

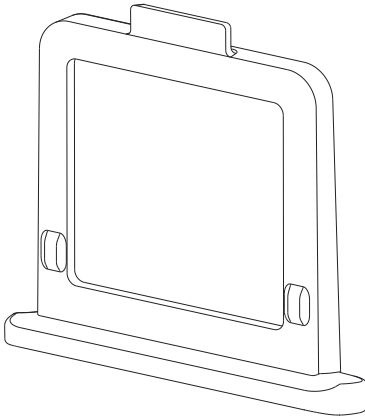

Reusable Filter

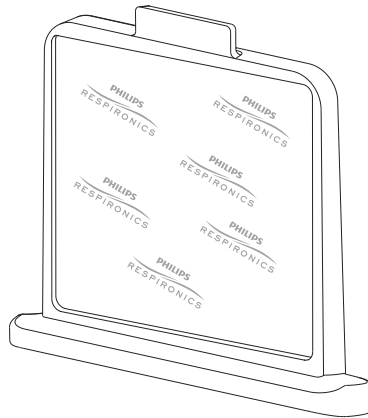

Disposable Fine Filter

The **reusable filter** screens out normal household dust and pollen. The reusable filter is supplied with your device.

The **disposable, fine filter** provides more complete filtration of fine particles. The disposable, fine filter is recommended for people who are sensitive to tobacco smoke or other small particles. The disposable, fine filter is sold separately. The disposable, fine filter contains Philips Respironics branding in the media (shown in the image above).

DO NOT rinse the disposable, fine filter.

When using the disposable, fine filter, the device performance may be affected. However, the device will remain functional and deliver therapy.

Installing or Replacing the Filter

One of the filters **must be in place at all times** to operate the device. If a filter is not already installed in the device, you must at least install the reusable filter before using your device.

The device has an automatic air filter reminder. Every 30 days, your device will display a message reminding you to check your filters and replace them as needed.

Note

The filter reminder is a message only. The device does not detect the performance of the filters, nor does it recognize when a filter has been replaced.

Follow these steps to install/replace a filter into your device:

1. If replacing an existing filter, pull out the old filter assembly.

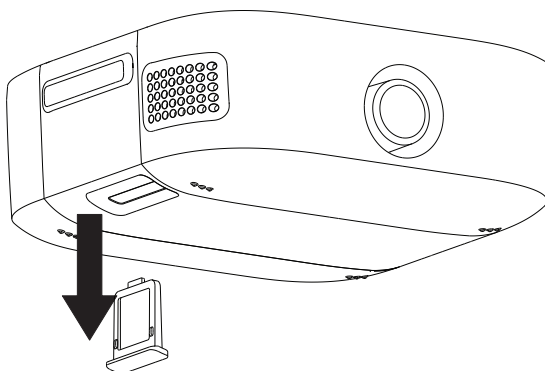

2. Insert a dry, reusable filter or a new, disposable, fine filter into the filter access on the device.

Filter Device Pop-Up Messages

Device pop-ups are messages that show up on the user interface screen.

Condition	Icon	Description	Possible Cause	Action
Inlet blocked. Check filter.		Blocked airway	Blockage at device inlet.	Check device air inlet is not obstructed. Check air filter(s) are installed properly; replace if needed.

6. Accessories

There are several accessories available for your DreamStation Go system, such as a microSD card, a travel kit or a battery pack. The device also comes with a USB port and a micro USB port. The travel kit is available for convenient portability while traveling with your device. Contact your supplier for additional information on the available accessories. When using optional accessories, always follow any instructions enclosed with the accessories.

Using the USB Port and the Micro USB Port

The DreamStation Go device comes with a USB port and a micro USB port. The USB port may be used to charge your mobile devices. The micro USB port may be used by your supplier to extract therapy data. Remove the cover over each port to access.

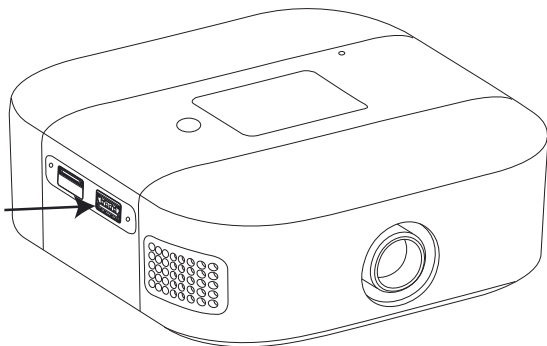

USB Port

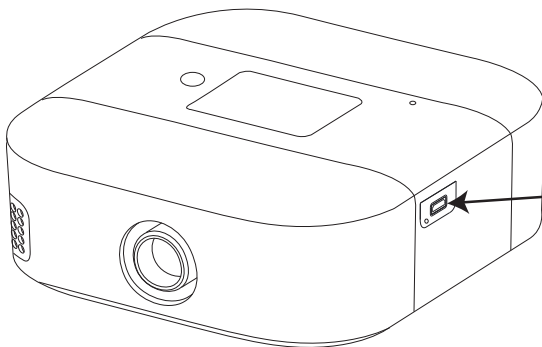

Micro USB Port

Using the microSD Card

The DreamStation Go system may come with a microSD card inserted in the microSD card slot on the side of the device to record information for your supplier. Your supplier may ask you to periodically remove the microSD card and send it to them for evaluation.

You will use the filter to remove the microSD card.

Turn off therapy and follow these steps to remove the microSD card:

1. Remove the filter from the device. Refer to the **Installing or Replacing the Filter** section in **Chapter 5** of this manual.

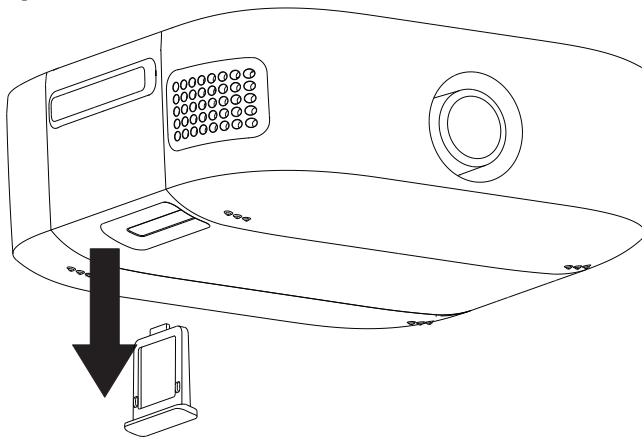



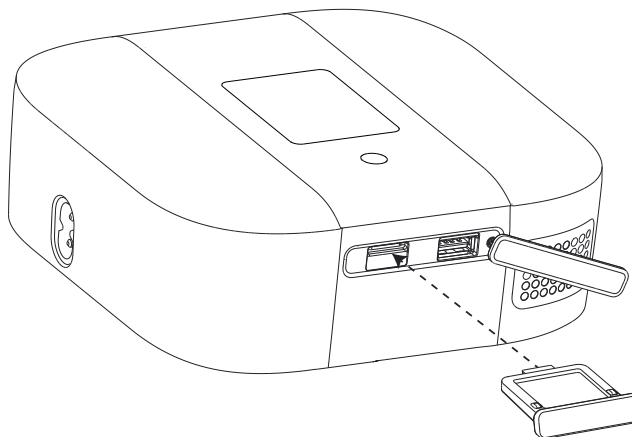

2. Use the end of the filter to push in on the microSD card. This will push the microSD card out of the device.



microSD Card Device Pop-Up Messages

Device pop-ups are messages that show up on the user interface screen.

Condition	Icon	Description	Possible Cause	Action
Data Activity: Do not remove microSD card		microSD card read/ write underway.	n/a	No action needed. Message will clear when the microSD card activity is finished.
microSD card removed		Indicates microSD card has been removed from therapy device and not reinserted before the start of the current therapy session.	microSD card was not reinserted into device.	Reinsert microSD card, or click to clear alert.
microSD card error: Remove and reinsert		microSD card error detected.	Device cannot read the microSD card. A problem may exist with the microSD card or it was ejected during a writing activity, or it was inserted incorrectly.	Remove microSD card and reinsert. If message reappears, contact your supplier for a replacement card.
microSD card full		microSD card is full.	microSD card is full.	Remove microSD card and replace with a new card from your supplier.

7. Battery Pack

Indicators and Buttons on the Battery Pack

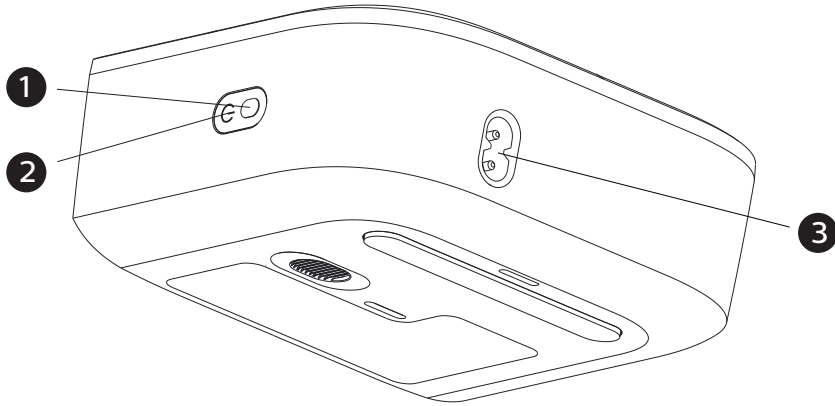

#	Feature
1	Push Button
2	LED Display
3	AC Power Inlet

- Push Button - The push button is located on the LED display of the battery pack.
- LED Display - The battery pack uses one green LED light to indicate the battery pack charge status when the battery pack is charging while not connected to the therapy device (standalone charging). The LED will be in one of the three modes:
 - * Steady ● when the battery pack is fully charged
 - * Blinking ✨ when charging
 - * Off ○ when connected to the therapy device

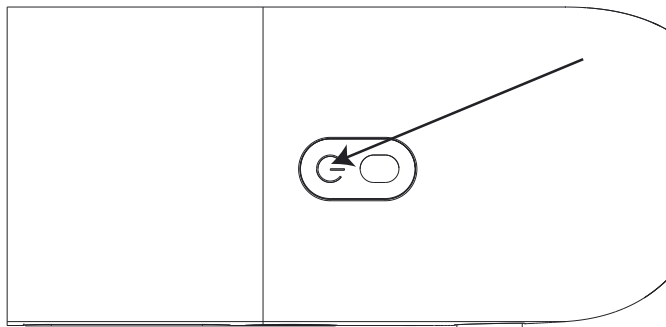

7. Battery Pack

- **Battery Pack Charge Indicator During Therapy** - The display touchscreen shows the current battery pack charge status in the lower right hand corner when the pack is connected and therapy is active (shown below). A fully charged battery pack is indicated by four charge bars. The white charge bars disappear as the battery pack charge decreases. Depending on your settings, mask leak and environmental conditions, a fully charged battery pack typically lasts 8 hours. For further information, speak with your supplier.



- **Battery Pack Charge Indicator When Therapy Is Not Active** - The display touchscreen will show the battery charge percentage when the battery is connected to the therapy device but not in use (shown below). This screen will appear in your main menu selections.

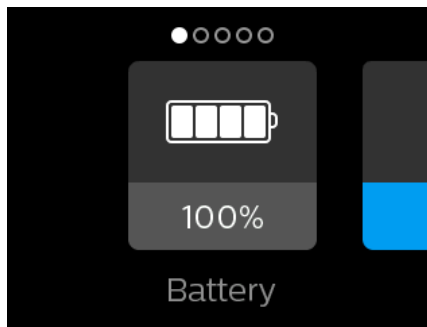

- **Battery Pack State of Charge Alert** - The display touchscreen will display a battery with a question mark in the center (shown below) when the charge level cannot be determined.



- Battery Pack Fault Alert - The display touchscreen will show a battery with an X inside (shown below) when a battery fault is detected.



Preparing the Battery Pack for First Use and Recharging

1. Remove the battery pack from the packaging.
2. Plug the end of the AC power cord into the battery pack.
3. Plug the AC power cord into an AC outlet. The battery pack will begin to charge automatically.
4. Once the battery pack is fully charged, it is ready for use with the DreamStation Go therapy device.

Notes

- Periodically charge the battery pack if not used regularly.
- Retain your packaging in case you ever need to return your battery pack to Philips Respironics.
- Before using the battery pack for the first time, you must plug it in until it is fully charged. This may take up to 5 hours.

Attaching the Battery Pack to the Device

After charging, your battery pack is ready to use. It can either be disconnected from the AC outlet and used as an external battery pack (standalone mode), or remain plugged into the AC outlet for a continuous, fully charged battery pack (uninterruptible power supply (UPS) mode).

To use the battery pack in UPS mode, follow the below steps:

1. Keep the battery pack plugged into the power source and connected to an AC outlet. This will allow you to use the battery pack continuously without losing any charge.

7. Battery Pack

2. Remove the battery pack end cap on the therapy device.

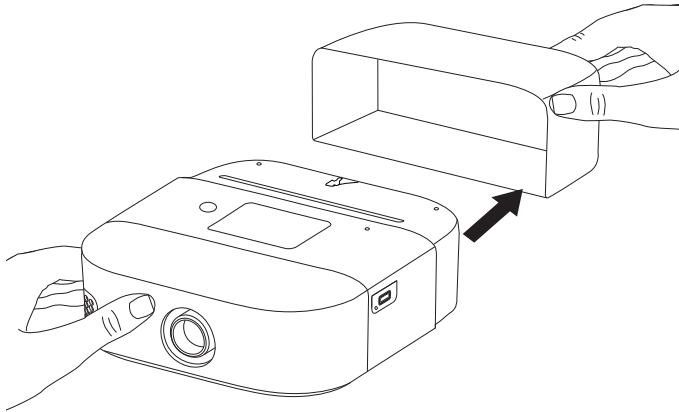

3. Slide the battery pack onto the device where the end cap was. Make sure the battery pack latches onto the therapy device.
4. Attach the AC power cord to the battery pack and then to the AC outlet.

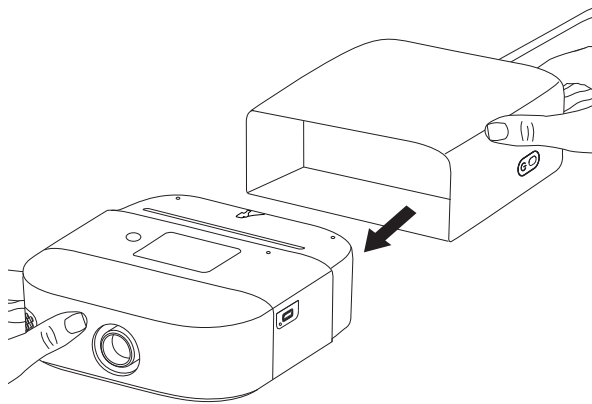

To use the battery pack in standalone mode, follow these steps:

1. Make sure the battery pack is fully charged. Disconnect the power cord from the AC outlet and disconnect the power cord from the therapy device. It can now be used with your therapy device as an external battery pack.
2. Remove the battery pack end cap on the therapy device.
3. Slide the battery pack onto the device where the end cap was. Make sure the battery pack latches onto the therapy device.
4. Momentarily push the battery pack push button to wake up the battery pack.

Notes

- The first time you charge your battery pack, it must be **fully charged** in accordance with the **Preparing the Battery Pack for First Use and Recharging** section. After the first charge is complete, the battery pack will charge while connected in UPS mode.
- To preserve battery life in UPS mode, the battery pack stops charging when it reaches full charge. The battery will start charging again when it depletes to 90% charge status.
- When the battery pack is used in standalone mode and the therapy device enters standby mode, the therapy device automatically shuts down the battery pack to preserve battery charge.

Disconnecting the Battery Pack

1. Disconnect the power cord.
2. Hold the battery pack push button down for 5 seconds, or the battery pack will shut off within 30 minutes when not in use.
3. The power down pop-up message will appear and the therapy device will power down and go dark.
4. You can now disconnect the battery pack. Disengage the battery pack by sliding the latch on the back of the pack, and pulling the battery pack away from the therapy device.

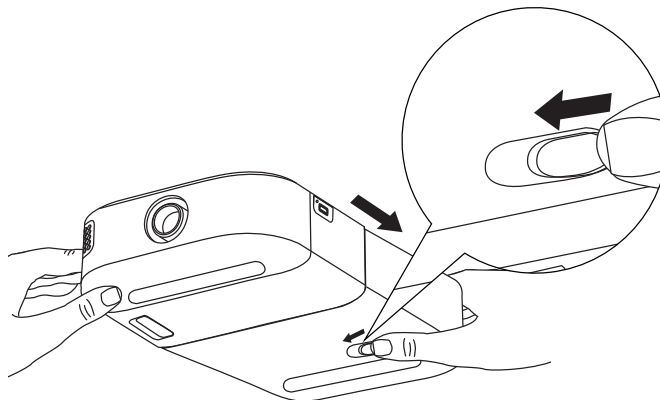

5. Replace the battery pack end cap on the therapy device.

8. Care and Maintenance

Caring for the Therapy Device or Battery Pack

Every two weeks of use, inspect your device or battery pack to see if it needs care.

1. To avoid electrical shock, make sure that the device and battery pack are disconnected from all outlets and power sources. Remove any cables attached to the device or battery pack.
2. Wipe the outside of the device or battery pack with a cloth slightly dampened with water.
3. Allow the device or battery pack to dry completely before reconnecting it to a power source, battery pack, device or cable.

Note

Inspect the device, battery pack, and all circuit parts (filter, tube and mask) for damage, such as cracks, tears or broken pieces. Replace any damaged parts.

Caring for the Reusable Filter

Under normal usage, you should rinse the reusable filter **at least once every two weeks** and replace it with a new one every **six months**.

The disposable, fine filter should be replaced after 30 nights of use, or sooner if it appears clogged. **DO NOT rinse the fine filter.**

Follow these steps to rinse the reusable filter:

1. If the device is operating, stop the airflow. Disconnect the device from the power source.
2. Remove the filter from the device. Refer to the **Installing or Replacing the Filter** section in **Chapter 5**.
3. Take the reusable filter to a sink, turn it upside down (tabs down), and run warm tap water through the white middle portion of the filter to rinse away any debris.
4. Shake the filter to remove as much water as possible.
5. **Allow the filter to air dry completely before reinstalling it.** If the filter is damaged, replace it.
6. Reinstall the filter into the filter access area on the device. **Refer to the Installing or Replacing the Filter** section in **Chapter 5**.

Notes

- Only Philips Respironics supplied filters should be used as replacement filters.
- Replace the disposable, fine filter if it is damaged or has accumulated debris.

9. Troubleshooting

Tips and Tricks

Your device is equipped with a self-diagnostic tool called **Performance Check**. This tool can evaluate your device for certain errors. It also allows you to share diagnostic information with your supplier. Use Performance Check when directed by your supplier.

The table below lists some of the problems you may experience with your device and possible solutions to those problems.

Contact customer service for assistance if none of the below troubleshooting tips work for you.

Problem	Why it happened	What to do
Nothing happens when you apply power to the device. The backlights on the buttons do not light.	There's no power at the outlet or the device is unplugged.	<ul style="list-style-type: none">• If you are using AC power: Check the outlet and verify that the device is properly plugged in, and that there is power available at the outlet. Make sure the AC power cord is connected correctly to the device's power inlet.• If you are using the battery pack: Make sure your battery pack is securely connected to your device. If the battery pack has been exposed to extreme temperatures, allow the battery back to cool or warm to room temperature. Check to see if your battery pack needs charged or replaced.
The airflow does not turn on.	There may be a problem with the blower.	<ul style="list-style-type: none">• Make sure the device is powered correctly.• Make sure the home screen appears on the user interface.• Press the therapy button on top of the device to start airflow. If the airflow does not turn on, there may be a problem with your device.

Problem	Why it happened	What to do
The device's display is erratic.	The device has been dropped or mishandled, or the device is in an area with several electronic devices.	Unplug the device. Reapply power to the device. If the problem continues, relocate the device to an area away from electronic equipment (such as cellular phones, cordless phones, computers, TVs, electronic games, hair dryers, etc.).
The Ramp feature does not work when you press the Ramp button.	Your supplier did not enable Ramp for you, or your therapy pressure is already set to the minimum setting.	<ul style="list-style-type: none"> • If ramp has not been enabled for you, discuss this feature with your supplier. • If your supplier has enabled ramp, but the feature still does not work, check the current pressure setting on the therapy screen. If the therapy pressure is set to the minimum setting (4.0 cm H₂O), or the ramp starting pressure is the same as the therapy pressure, the ramp feature will not work. Make sure that the ramp time setting is >0.
The airflow is much warmer than usual.	The air filters may be dirty. The device may be operating in direct sunlight or near a heater.	<ul style="list-style-type: none"> • Rinse or replace the air filter. • The temperature of the air may vary somewhat based on your room temperature. • Make sure that the device is properly ventilated. Keep the device away from bedding or curtains that could block the flow of air around the device. • Make sure the device is away from direct sunlight and heating equipment.
The airflow pressure feels too high or too low.	The tubing type setting may be incorrect.	Make sure the tubing type setting (12, 15 or 22) matches the tubing that you are using (Philips Respironics 12, 15 or 22 tubing type).

9. Troubleshooting

Problem	Why it happened	What to do
I hear a leak or whistling sound coming from my therapy device (not related to mask leak).	The therapy device air inlet may be obstructed.	<ul style="list-style-type: none">• Check therapy device air inlet is not obstructed, and filter has not accumulated excessive debris and is properly inserted.• Confirm that the device and tube are connected properly and not leaking.
The battery pack LEDs will not light up while charging.	Your battery pack may have been damaged.	If the battery pack is completely depleted of charge, wait a few minutes for the LEDs to light up. If the LEDs still do not light up, replace your battery pack. If the battery pack has been exposed to extreme temperatures, allow the battery pack to cool or warm to room temperature.
The battery pack LED is rapidly flashing.	Your battery pack may have been damaged.	If the battery pack has been exposed to extreme temperatures, allow the battery pack to cool or warm to room temperature. Unplug the battery pack from the power cord, then plug the power cord back into the battery pack. If the LED continues to rapidly flash, replace your battery pack.
“Service Required” shown on display.	A device error has occurred and placed the device into safe state.	Disconnect power cord. Reattach the power cord to restore power. If the alert continues, contact your supplier.

Contacting Customer Service

Should you experience trouble with this equipment or require assistance setting up, using, or maintaining the device or accessories, please contact your supplier. If you need to contact Philips Respironics directly, call the Philips Respironics Customer Service department at 1-724-387-4000 or 1-800-345-6443. You can also use the following address:

Respironics, Inc.

1001 Murry Ridge Lane

Murrysville, PA 15668

10. Additional Notes

Traveling with the System

When traveling, the optional case is for carry-on luggage only. The optional case will not protect the system if it is put through checked baggage.

For your convenience at security stations, there is a note on the bottom of the device stating that it is medical equipment and is suitable for airline use. It may be helpful to bring this manual along with you to help security personnel understand the DreamStation Go device.

If you are traveling to a country with a line voltage different than the one you are currently using, a different power cord or an international plug adaptor may be required to make your power cord compatible with the power outlets of the country to which you are traveling. Contact your supplier for additional information.

Airline Travel

The device is suitable for use on airlines when the device is operating from an AC power source or battery pack.

Altitude Compensation

This device automatically compensates for altitude up to 7,500 feet. No manual adjustment is necessary.

Adding Supplemental Oxygen

Oxygen can be added to the patient circuit.

Notes

- Refer to the pressure valve's instructions for complete setup information.
 - When using oxygen with this system, turn the device on before turning on the oxygen. Turn the oxygen off before turning the device off. This will prevent oxygen accumulation in the device.
 - Do not connect the device to an unregulated or high pressure oxygen source.
-

Service

The device does not require routine servicing.

Additional Notices

Notices:

- The *Bluetooth*® word mark and logos are registered trademarks owned by Bluetooth SIG, Inc. and any use of such marks by Philips Respironics is under license. Other trademarks and trade names are those of their respective owners.
- The DreamStation Go Therapy Device transmits data between the therapy device and a mobile device, but it does not store any of your personal data. This connection between the therapy device and a mobile device is encrypted.
- This device contains a FCC certified *Bluetooth* radio module (located on the main board). FCC ID: THO1116426
- Use of non-original manufacturer-approved accessories may violate your local RF exposure guidelines and should be avoided.
- This device complies with part 15 of the FCC Rules. Operation is subject to the following two conditions: (1) This device may not cause harmful interference, and (2) this device must accept any interference received, including interference that may cause undesired operation. This equipment has been tested and found to comply with the limits for a Class B digital device, pursuant to Part 15 of the FCC Rules. These limits are designed to provide reasonable protection against harmful interference in a residential installation. This equipment generates, uses, and can radiate radio frequency energy and, if not installed and used in accordance with the instructions, may cause harmful interference to radio communications. However, there is no guarantee that interference will not occur in a particular installation. If this equipment does cause harmful interference to radio, TV reception, or other devices which can be determined by turning the equipment on and off, the user is encouraged to try to correct the interference by one or more of the following measures:
 - Reorient or relocate the receiving antenna (on the radio, TV, or other device).
 - Increase the separation between the equipment and receiver.
 - Connect the equipment into an outlet on a circuit different from that to which the receiver is connected.
 - Consult the dealer of the device for help.
- Any changes or modifications made to the device that are not expressly approved by Respironics may void the user's authority to operate the equipment.

Specifications

Environmental

Operating Temperature	Device: 5° to 35° C (41° to 95° F)
	Battery Pack: 5° to 35° C (41° to 104° F)
Storage Temperature	-20° to 60° C (-4° to 140° F)
Relative Humidity (operating & storage)	15 to 95% (non-condensing)
Atmospheric Pressure:	Device: 101 to 77 kPa (0 - 2286 m / 0 - 7500 ft)
	Battery Pack: 101 to 77 kPa (0 - 2286 m / 0 - 7500 ft)

Physical

Dimensions	Device: 150.8 x 150.8 x 58.8 mm (5.937" L x 5.937" W x 2.315" H)
	Battery Pack: 122 x 150.8 x 58.8 mm (4.803" L x 5.937" W x 2.315" H)
Weight	Device: Approximately 854 g (1.88 lb.)
	Battery Pack: Approximately 696 g (1.53 lb.)

Service life

The expected service life of the DreamStation Go therapy device is 5 years.

The expected service life of the battery pack is 3 years.

Standards compliance

This device is designed to conform to the following standards:

- IEC 60601-1 General Requirements for Basic Safety and Essential Performance of Medical Electrical Equipment
- ISO 80601-2-70 Sleep Apnea Breathing Therapy Equipment
- EN 60601-1-2 Electromagnetic Compatibility
- RTCA/DO-160G section 21, category M; Emission of Radio Frequency Energy

IEC 60601-1 classification

Type of Protection Against Electric Shock	Class II Equipment/Internally Powered
Degree of Protection Against Electric Shock	Type BF Applied Part
Degree of Protection against Ingress of Water	<p>Device: Drip Proof, IP22</p> <p>First characteristic numeral - 2 - Protection against ingress of solid foreign objects ≥ 12.5 mm diameter. Explanation: Protected against access to hazardous parts with a finger and protected against solid foreign objects of 12.5 mm diameter and greater.</p> <p>Second characteristic numeral - 2- Protection against ingress of water with harmful effects dripping (15° tilted). Explanation: Protected against vertically falling water drops when enclosure tilted up to 15°.</p>
Mode of Operation	Continuous

Electrical

AC Power Consumption	100–240 VAC, 50/60 Hz, 2.0-1.0 A
Fuses	There are no user-replaceable fuses.
USB Charging Port Output	5 VDC, 7.5 W (1.5 A)

Electrical for the Battery Pack

Run Time	> 8 hours
Output voltage range	18-24.6 VDC
Battery technology	Lithium Ion
Capacity	62 Wh
Input voltage range	100-240 VAC, 50/60 Hz, 2.0-1.0 A
Output power (max continuous)	50W
Minimum life cycle	$\geq 70\%$ of rated capacity after 500 cycles
Recharge time	< 5 hours

Radio Specifications

Operating Frequency Range	2402 - 2480 MHz
Maximum Output Power	4.0 dBm
Modulation	GFSK, P/4 DQPSK, 8DQPSK

Intake port filters

Reusable Filter	100% Polyester 88% Efficient @ 7-10 micron size
Fine Filter	Blended Synthetic Fiber 95% Efficient @ 0.5-0.7 micron size

Declared dual-number noise emissions values (in accordance with ISO 4871)

Tube Size	Sound Pressure Level (L)	Uncertainty (K)	Sound Power Level	Uncertainty (K)
12 (mm) tubing type	30.4 dB(A)	2 dB(A)	38.4 dB(A)	2 dB(A)
15 (mm) tubing type	29.9 dB(A)	2 dB(A)	37.9 dB(A)	2 dB(A)
22 (mm) tubing type	29.8 dB(A)	2 dB(A)	37.8 dB(A)	2 dB(A)

Note

Values determined according to noise test code given in ISO 80601-2-70:2015, using the basic standards ISO 3744 and ISO 4871.

Pressure Accuracy

Pressure Increments: 4.0-20.0 cmH₂O (in 0.5 cmH₂O increments)

Maximum static pressure accuracy, according to ISO 80601-2-70:2015:

Tube Type	Pressure	Accuracy
12 (mm) tubing type	10 cmH ₂ O	± 1.0 cmH ₂ O
15 (mm) tubing type and 22 (mm) tubing type	10 cmH ₂ O	± 0.5 cmH ₂ O

Static pressure accuracy has a measurement uncertainty of 3.8%

10. Additional Notes

Maximum dynamic pressure variation, according to ISO 80601-2-70:2015:

Tube Type	10 BPM	15 BPM	20 BPM
12 (mm) tubing type	± 0.6 cmH ₂ O	± 0.8 cmH ₂ O	± 1.6 cmH ₂ O
15 (mm) tubing type and 22 (mm) tubing type	± 0.7 cmH ₂ O	± 0.7 cmH ₂ O	± 1.0 cmH ₂ O

Dynamic pressure accuracy has a measurement uncertainty of 3.6%.

Maximum Flow Rate (typical)

Tube Type	Flow	Test pressures (cmH ₂ O)				
		4.0	8.0	12.0	16.0	20.0
12 (mm) tubing type	Average flow at the patient connection port (l/min)	90	119	112	106	99
15 (mm) tubing type	Average flow at the patient connection port (l/min)	77	115	112	105	106
22 (mm) tubing type	Average flow at the patient connection port (l/min)	80	121	127	121	109

Disposal

Separate collection for electrical and electronic equipment per EC Directive 2012/19/EU. Dispose of this device in accordance with local regulations.

EMC information

Your unit has been designed to meet EMC standards throughout its service life without additional maintenance. There is always an opportunity to relocate your DreamStation Go Therapy Device within an environment that contains other devices with their own unknown EMC behavior. If you believe your unit is affected by locating it closer to another device, simply separate the devices to remove the condition.

Pressure and Flow Accuracy

The DreamStation Go Therapy Device is designed to perform within the pressure and flowrate accuracies specified in the user manual. If you suspect that the pressure and/or flow rate accuracy is affected by EMC interference remove power and relocate the device to another area. If performance continues to be affected discontinue use and contact your supplier.

Guidance and Manufacturer's Declaration - Electromagnetic Emissions – This device is intended for use in the electromagnetic environment specified below. The user of this device should make sure it is used in such an environment.

EMISSIONS TEST	COMPLIANCE	ELECTROMAGNETIC ENVIRONMENT – GUIDANCE
RF emissions CISPR 11	Group 1	The device uses RF energy only for its internal function. Therefore, its RF emissions are very low and are not likely to cause any interference in nearby electronic equipment.
RF emissions CISPR 11	Class B	The device is suitable for use in all establishments, including domestic establishments and those directly connected to the public low-voltage power supply network.
Harmonic emissions IEC 61000-3-2	Class A	
Voltage fluctuations/ Flicker emissions IEC 61000-3-3	Complies	
Emission of Radio Frequency Energy RTCA/DO-160G Section 21	Category M	This device is suitable for use onboard commercial airplanes inside passenger cabin.

Guidance and Manufacturer's Declaration – Electromagnetic Immunity – This device is intended for use in the electromagnetic environment specified below. The user of this device should make sure it is used in such an environment.

IMMUNITY TEST	IEC 60601 TEST LEVEL	COMPLIANCE LEVEL	ELECTROMAGNETIC ENVIRONMENT – GUIDANCE
Electrostatic Discharge (ESD) IEC 61000-4-2	±8 kV contact ±15 kV air	±8 kV contact ±15 kV air	Floors should be wood, concrete or ceramic tile. If floors are covered with synthetic material, the relative humidity should be at least 30%.
Electrical fast Transient/burst IEC 61000-4-4	±2 kV for power supply lines ±1 kV for input-output lines	±2 kV for supply mains ±1 kV for input/output lines	Mains power quality should be that of a typical home or hospital environment.
Surge IEC 61000-4-5	±1 kV differential mode ±2 kV common mode	±1 kV differential mode ±2 kV for common mode	Mains power quality should be that of a typical home or hospital environment.

10. Additional Notes

IMMUNITY TEST	IEC 60601 TEST LEVEL	COMPLIANCE LEVEL	ELECTROMAGNETIC ENVIRONMENT - GUIDANCE
Voltage dips, short interruptions and voltage variations on power supply input lines IEC 61000-4-11	<p><5% U_T (>95% dip in U_T) for 0.5 cycle at 45 degree increments</p> <p><5% U_T (>95% dip in U_T) for 1 cycle</p> <p>70% U_T (30% dip in U_T) for 0.5 seconds</p> <p><5% U_T (>95% dip in U_T) for 5 seconds</p>	<p><5% U_T (>95% dip in U_T) for 0.5 cycle at 45 degree increments</p> <p><5% U_T (>95% dip in U_T) for 1 cycle</p> <p>70% U_T (30% dip in U_T) for 0.5 seconds</p> <p><5% U_T (>95% dip in U_T) for 5 seconds</p>	Mains power quality should be that of a typical home or hospital environment. If the user of the device requires continued operation during power mains interruptions, it is recommended that the device be powered from an uninterruptible power supply or a battery.
Power frequency (50/60 Hz) magnetic field IEC 61000-4-8	30 A/m	30 A/m	Power frequency magnetic fields should be at levels characteristic of a typical location in a typical hospital or home environment.

NOTE: U_T is the a.c. mains voltage prior to application of the test level.

Guidance and Manufacturer's Declaration - Electromagnetic Immunity – This device is intended for use in the electromagnetic environment specified below. The user of this device should make sure it is used in such an environment.

Immunity Test	IEC 60601 Test Level	Compliance Level	Electromagnetic Environment - Guidance
<p>Conducted RF IEC 61000-4-6</p> <p>Radiated RF IEC 61000-4-3</p>	<p>3 Vrms 150 kHz to 80 MHz</p> <p>6 Vrms Amateur Radio & ISM Bands between 150 kHz and 80 MHz</p> <p>10 V/m 80 MHz to 2.7 GHz</p> <p>Special Telecommunication Bands between 300 MHz and 5.6 GHz</p>	<p>3 Vrms 150 kHz to 80 MHz</p> <p>6 Vrms Amateur Radio & ISM Bands between 150 kHz and 80 MHz</p> <p>10 V/m</p> <p>Up to 28 V/m</p>	<p>Portable and mobile RF communications equipment should be used no closer to any part of the device, including cables, than the recommended 30 cm separation distance.</p> <p>Interference may occur in the vicinity of equipment marked with the following symbol: </p>

Limited Warranty

Respironics, Inc., a Philips company, warrants that the system shall be free from defects of workmanship and materials and will perform in accordance with the product specifications for a period of two (2) years for the therapy device and a period of one (1) year for the battery pack from the date of sale by Respironics, Inc. to the dealer. If the product fails to perform in accordance with the product specifications, Respironics, Inc. will repair or replace – at its option – the defective material or part. Respironics, Inc. will pay customary freight charges from Respironics, Inc. to the dealer location only. This warranty does not cover damage caused by accident, misuse, abuse, alteration, water ingress, and other defects not related to material or workmanship. The Respironics, Inc. Service department shall examine any devices returned for service, and Respironics, Inc. reserves the right to charge an evaluation fee for any returned device as to which no problem is found after investigation by Respironics, Inc. Service.

This warranty is non-transferable by unauthorized distributors of Respironics, Inc. products and Respironics, Inc. reserves the right to charge dealers for warranty service of failed product not purchased directly from Respironics, Inc. or authorized distributors.

Respironics, Inc. disclaims all liability for economic loss, loss of profits, overhead, or consequential damages which may be claimed to arise from any sale or use of this product. Some states do not allow the exclusion or limitation of incidental or consequential damages, so the above limitation or exclusion may not apply to you.

This warranty is given in lieu of all other express warranties. In addition, any implied warranties – including any warranty of merchantability or fitness for the particular purpose – are limited to two years. Some states do not allow limitations on how long an implied warranty lasts, so the above limitation may not apply to you. This warranty gives you specific legal rights, and you may also have other rights which vary from state to state. To exercise your rights under this warranty, contact your local authorized Respironics, Inc. dealer or contact Respironics, Inc. at:

1001 Murry Ridge Lane

Murrysville, Pennsylvania 15668-8550

1-724-387-4000



Respironics Inc.
1001 Murry Ridge Lane
Murrysville, PA 15668 USA



REF 1128239

1128239 R03
AD 3/7/2017
EN-DOM